

# THE ECLIPSE

Brochures for:  
Eclipse  
Eclipse Premier  
Total Eclipse  
Solar Eclipse  
Drop Arm  
are found in this document





# THE ECLIPSE





# UNIQUELY DESIGNED



## CUSTOM BUILT TO YOUR SPECIFICATIONS

Every Eclipse shading system is custom made and professionally installed by our independent dealers to meet your individual requirements. The Eclipse model is available up to 40' wide with projections up to 11' 6" (up to 22' wide x 11' 6" projection with the semi cassette option). Eclipse shading components meet stringent ISO 9001 and TUV standards and are assembled in the USA by skilled craftspeople.



## ADVANCED BELT TECHNOLOGY

While others have exposed cables or chains Eclipse incorporates our unique Advanced Belt Technology - ABT. Our Eclipse model ABT consists of 9 individually wound cables encased in a poly-carbon, UV resistant coating. This time proven feature has been an Eclipse exclusive from our beginning and will provide you with a long, worry free life for your shading system.



# TO MEET YOUR NEEDS



## MOTORIZED FOR EASY USE

Your Eclipse features a UL listed motor from Somfy, the world leader in home automation. You can operate your shading system with a wireless wall switch, a hand held remote, a smart device... or from all of these! To further increase the effectiveness of your shading system, we offer automatic sun and motion sensors - ask your dealer for more details.

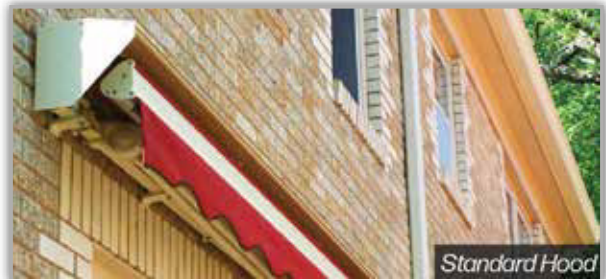

## MOUNTING AND FABRIC PROTECTION

The Eclipse can be ordered 3 ways:

- With a fully exposed rolled up fabric referred to as an "Open Roller" - typically for under soffit mounting
- With a protective Standard Hood for wall mounting
- With a Semi Cassette providing full fabric protection for any mounting application - we recommend this option especially when roof mounting up to 22' wide x 11'6" projection



# PRODUCT OPTIONS



## DROP SHADE

Add even more solar protection while increasing your privacy with the Eclipse Drop Shade. This option features an open mesh, sun screen fabric that extends down from the front bar over the width of the awning. The Drop Shade is self storing and motorized. This option is not available with the Semi Cassette.



## LUNAR LIGHTING

Add a unique element to your evening entertaining with several lighting options. Lunar Lighting (shown) is typically applied to the back of the front bar and offers a soft warm glow light which can be turned on or off with the same multi-channel remote/transmitter as your awning. An LED lighting option is available with light strips applied to the arms of the awning (dealer installed). This UL-listed LED light kit offers 16 levels of light in either warm (3000K) or cool (6000K) lighting and like lunar lighting, can be controlled with the same multi-channel remote/transmitter or multi-channel wireless wall switch. Research suggests that warm lights attract less bugs.

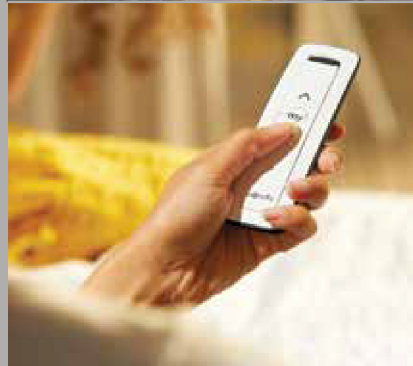

## ELECTRONIC ACCESSORIES

Our world class wireless components make operating your shading system effortless.

- Wind/Motion Sensor: This accelerometer sensor attached to the awning's framework will retract the unit if it gets too windy – adding a level of safety and security.
- Sun Sensor: This sensor, typically mounted to an exterior wall, will automatically extend the awning once the preset sun level is attained, and will automatically retract your shading system when the sun passes.
- TaHoma: With TaHoma®, create scenarios to link your connected devices and activate them with just a click on your smartphone!



## SEMI CASSETTE HOOD

Completely protect your fabric from the elements and increase your level of security with the Semi Cassette option. This option is available on the Eclipse model up to 22' wide x 11'6" projection.

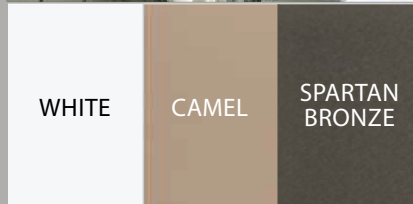

## HARDWARE TO MATCH YOUR DÉCOR

Eclipse offers three architecturally pleasing colors to either match or accentuate your home. Our pretreated powder coated finishes are second to none in durability and appearance.



## SUNBRELLA SHADE FABRICS - FROM SERENE TO STUNNING

Eclipse offers a wide array of long lasting, fade resistant, 100% acrylic fabrics from Sunbrella. The Sunbrella Shade fabrics are specifically made for heavy duty applications such as retractable awnings. Each fabric cover is computer cut, has ultrasonically sealed edges, and is sewn with Tenera thread to provide a full 10 year warranty on the fabric and the seams. Make a bold statement or blend harmoniously to your home's décor... whatever your choice, we have the fabric for you.



## AN ADDED LEVEL OF SECURITY

Looking for a lifetime warranty on your complete shading system – from frame to fabric, motor and electronics? Ask your dealer for complete details on our platinum protection programs.



# THE NEXT GENERATION IN SHADING



## DELIVERING VALUE

The Eclipse is our signature model of shading systems. This time tested model has shaded homes and expanded outdoor living throughout the country since our company's inception. The Eclipse offers excellent value by incorporating a full line of product options, allowing you to design a shading system to fit your individual needs. Eclipse has been rated as the #1 brand of retractable awnings for 10 years running!

## ENDURING PERFORMANCE

The Eclipse can be mounted on virtually any surface and is ideal for both residential and commercial applications. This "green" solution will expand your living space, reduce interior solar heat gain, block glare and prevent fading of your furnishings - year after year. Add a European cafe' feel to your home and make the most of your outdoor living. With dozens of long lasting fabrics in an array of designer colors and patterns, you can create your own getaway just a few steps out of your door. The Eclipse is a fully retractable shading system. With the touch of a button, you can fully retract your awning, keeping it safe from the elements when not in use.





# PRODUCT FEATURE OPTIONS

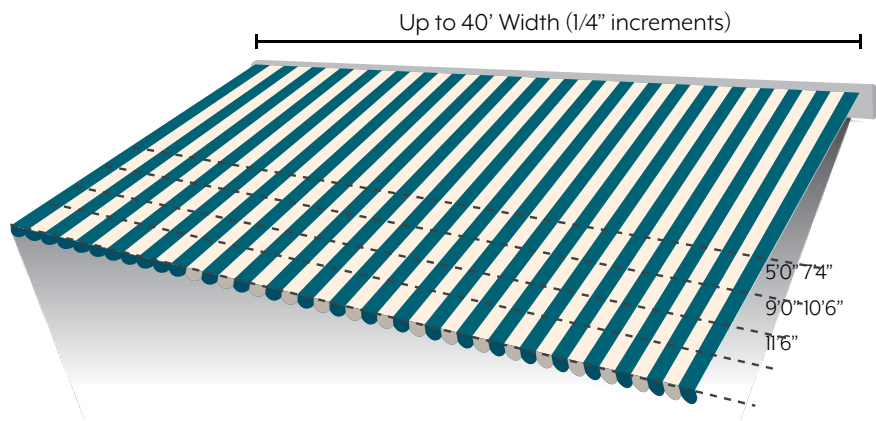

## SIZES AVAILABLE

The Eclipse shading system is custom made to fit your unique space. With widths up to 40' wide and projections up to 11'6", we've got you covered!

The Eclipse components meet stringent ISO 9001 and TUV standards and are assembled in the USA by skilled craftspeople.



## PRODUCT WARRANTY\*

10 years on Frame  
10 years on Fabric  
5 years on motor and electronics

\*Please review warranty for complete details



## ADVANCED BELT TECHNOLOGY

The Eclipse exclusive tension transmission system, has been tested and proven for almost 2 decades on performance. This design does not stretch or breakdown over time, keeping your fabric taut for years to come.

## ARM LIFE EXPECTANCY:

➔	ABT	—	<b>60,000 Cycles</b>
	CHAIN	—	8,000 Cycles
	CABLE	—	5,000 Cycles



## ALUMINUM TORSION BAR

The Eclipse features a non corrosive torsion bar that is powder coated to match the framework of the awning.



ROOF MOUNT SOFFIT MOUNT

## MOUNTING

Wall, soffit, or roof mounting available to match your needs.



## MOTORIZED

Easy motorized touch of a button. Operation includes the functionality of a manual override feature should you lose power.



Your independently owned and operated dealer

EL6P124

99.2% of Eclipse customers would recommend us to a friend or neighbor. (based on 2022 & 2023 Eclipse owners feedback)

Verified, third party customer reviews since 1/1/18 to date  
Powered by:



Product Rating 4.9



Dealer Rating 4.8

For more photos, customer feedback and additional product details, please visit:

[ECLIPSESHADING.COM](http://ECLIPSESHADING.COM)



# ECLIPSE PREMIER





# UNIQUELY DESIGNED



## CUSTOM BUILT TO YOUR SPECIFICATIONS

Every Eclipse shading system is custom made and professionally installed by our independent dealers to meet your individual requirements. The Eclipse Premier is available up to 40' wide with projections up to 13'. Eclipse components meet stringent ISO 9001 and TUV standards and are assembled in the USA by skilled craftspeople.



## TRULY THE INDUSTRY LEADERS

### Eclipse Premier Arms:

- The Eclipse brand exclusive ABT arm belt is hidden - clean finished look and 21% more arm tension than our Eclipse model - stronger, tighter fabric.
- Tested to 72,000 cycles - 20% more expected life than the Eclipse model.
- Thicker, contoured arm profiles - reduced arm deflection.
- Sealed dual ball bearing elbows with a larger radius curve - smoother operation and better arm tension.



Premier Arms

Standard Arms



# TO MEET YOUR NEEDS



## MOTORIZED FOR EASY USE

Your Eclipse Premier features a UL listed motor from Somfy, the world leader in home automation. You can operate your shading system with a wireless wall switch, a hand held remote, from your smart device... or from all of these! To increase the usefulness and effectiveness of your shading system, plus add a level of protection, Eclipse also offers sun sensors and motion sensors.

## MOUNTING AND FABRIC PROTECTION

The Eclipse Premier can be ordered in three ways:

- With a fully exposed rolled up fabric referred to as an “Open Roller” - typically for under soffit mounting.
- With a protective Standard Hood, ideal for wall mounting.
- With a Semi Cassette providing full fabric protection for any mounting application - we recommend this option especially for roof mounting.

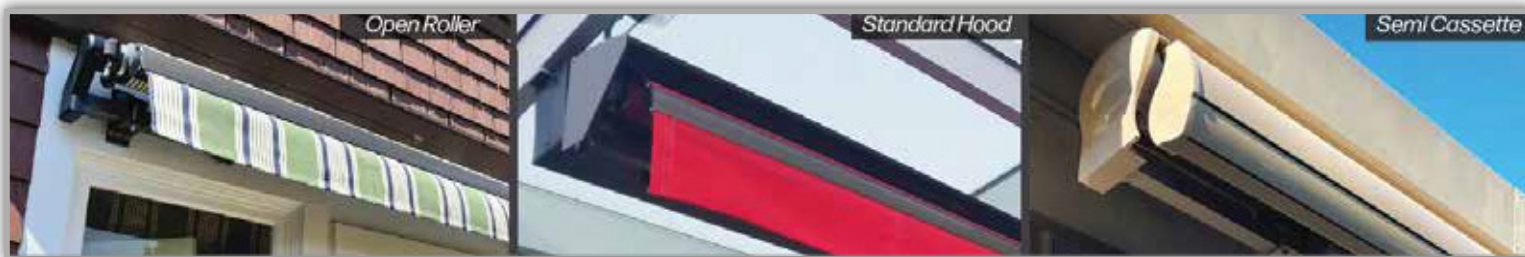

# PRODUCT OPTIONS



## DROP SHADE

Add even more solar protection while increasing your privacy with the Eclipse Drop Shade. This option features an open mesh, sun screen fabric that extends down from the front bar over the width of the awning. The Drop Shade is self storing and motorized. This option is not available with the Semi Cassette.



## LUNAR LIGHTING

Add a unique element to your evening entertaining with several lighting options. Lunar Lighting (shown) is typically applied to the back of the front bar and offers a soft warm glow light which can be turned on or off with the same multi-channel remote/transmitter as your awning. An LED lighting option is available with light strips applied to the arms of the awning (dealer installed). This UL-listed LED light kit offers 16 levels of light in either warm (3000K) or cool (6000K) lighting and like lunar lighting, can be controlled with the same multi-channel remote/transmitter or multi-channel wireless wall switch. Research suggests that warm lights attract less bugs.



## ELECTRONIC ACCESSORIES

Our world class wireless components make operating your shading system effortless.

- Wind/Motion Sensor: This accelerometer sensor attached to the awning's framework will retract the unit if it gets too windy – adding a level of safety and security.
- Sun Sensor: This sensor, typically mounted to an exterior wall, will automatically extend the awning once the preset sun level is attained, and will automatically retract your shading system when the sun passes.
- TaHoma: With TaHoma®, create scenarios to link your connected devices and activate them with just a click on your smartphone!

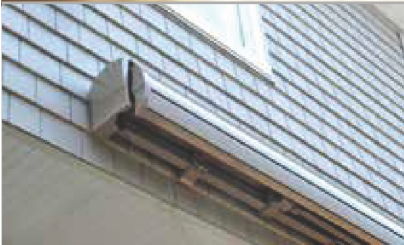

## SEMI CASSETTE HOOD

Completely protect your fabric from the elements and increase your level of security with the Semi Cassette option.

Note: 13' projection requires 3'3" minimum pitch/drop.

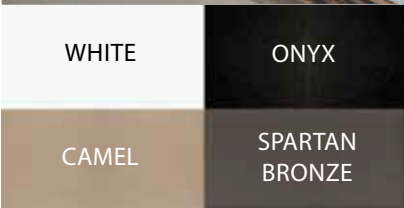

## HARDWARE TO MATCH YOUR DÉCOR

Eclipse offers four architecturally pleasing colors to either match or accentuate your home. Our pretreated powder coated finishes are second to none in durability and appearance.



## SUNBRELLA SHADE FABRICS - FROM SERENE TO STUNNING

Eclipse offers a wide array of long lasting, fade resistant, 100% acrylic fabrics from Sunbrella. The Sunbrella Shade fabrics are specifically made for heavy duty applications such as retractable awnings. Each fabric cover is computer cut, has ultrasonically sealed edges, and is sewn with Tenara thread to provide a full 10 year warranty on the fabric and the seams. Make a bold statement or blend harmoniously to your home's décor... whatever your choice, we have the fabric for you.



## AN ADDED LEVEL OF SECURITY

Looking for a lifetime warranty on your complete shading system – from frame to fabric, motor and electronics? Ask your dealer for complete details on our platinum protection programs.





# THE NEXT GENERATION IN SHADING

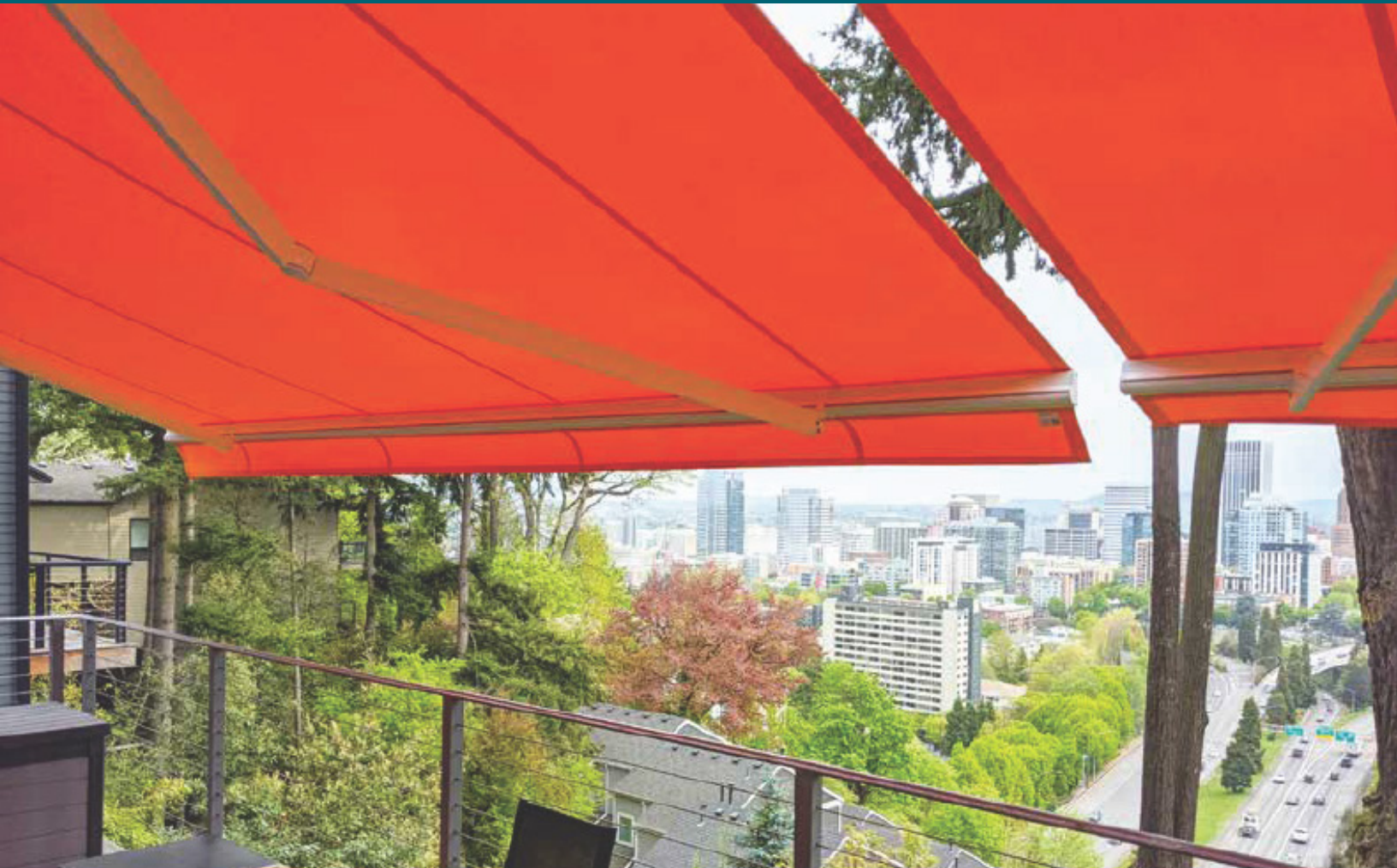

## DELIVERING VALUE

The Eclipse Premier is the upgraded, "Gold Standard" of the Eclipse model, our most popular unit. The Premier offers the latest key product enhancements to ensure a long lasting, trouble free shading system. The Premier is confidently backed with our extended Platinum Protection Warranty package included at no additional cost.

## ELEGANT PERFORMANCE

The Eclipse Premier features components that provide a refined, finished look while adding strength and durability to the system. The aluminum powder coated torsion bar has been upgraded to a stronger, thicker wall profile to increase unit rigidity. The retractable arms are where you'll notice the greatest improvements. These arms feature larger arm profiles, a concealed heavy duty arm belt, and sealed ball bearings at the elbow for an overall contoured designer shade.





# PRODUCT FEATURE OPTIONS

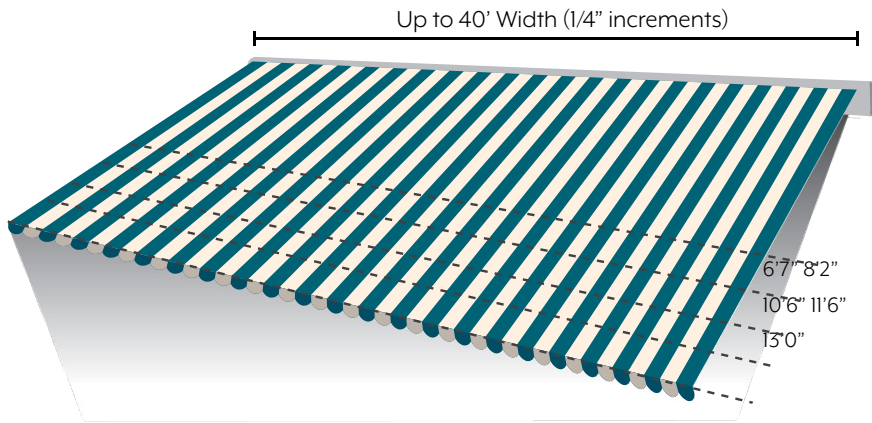

## SIZES AVAILABLE

The Eclipse Premier shading system is custom made to fit your unique space. With widths up to 40' wide and projections up to 13', we've got you covered!

The Eclipse Premier components meet stringent ISO 9001 and TUV standards and are assembled in the USA by skilled craftspeople.



## PRODUCT WARRANTY\*

Lifetime Frame  
12 years on fabric  
8 years on motor and electronics  
\*Please review warranty for complete details



## PREMIER ARMS

Incorporates sealed ball bearings and larger profiles providing smooth and quiet operation.



## CONCEALED ABT

The larger, internally hidden, belt means a cleaner finished look with a tighter fabric cover.

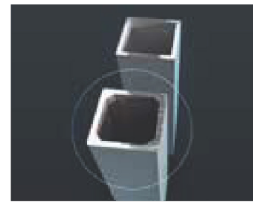

## HEAVY DUTY TORSION BAR

The Premier torsion bar is 15% heavier than our standard bar. This provides a stable shading system with less bouncing in light winds.



## MOTORIZED

Easy motorized touch of a button. Operation includes the functionality of a manual override feature should you lose power.



## MOUNTING

Wall, soffit, or roof mounting available to match your needs.

ROOF MOUNT SOFFIT MOUNT

## ARM LIFE EXPECTANCY:

➔ ABT — **72,000 Cycles**  
CHAIN 8,000 Cycles  
CABLE 5,000 Cycles



Your independently owned and operated dealer

99.2% of Eclipse customers would recommend us to a friend or neighbor. (based on 2022 & 2023 Eclipse owners feedback)

Verified, third party customer reviews since 1/1/18 to date  
Powered by:



Product Rating 4.9



Dealer Rating 4.8

For more photos, customer feedback and additional product details, please visit:

[ECLIPSESHADING.COM](http://ECLIPSESHADING.COM)



# SOLAR ECLIPSE



# UNIQUELY DESIGNED



## BUILT TO LAST, PROFESSIONALLY INSTALLED

Every Eclipse shading system is custom made and professionally installed by our independent dealers to meet your individual requirements. The Solar Eclipse unit is available up to 23' wide with projections up to 13'. Eclipse components meet stringent ISO 9001 and TUV standards and are assembled in the USA by skilled craftspeople.



## TRULY THE INDUSTRY LEADER

### Solar Eclipse Arms:

- The Eclipse brand exclusive ABT arm belt is hidden - clean finished look and 21% more arm tension than our Eclipse model - stronger, tighter fabric.
- Tested to 72,000 cycles - 20% more expected life than the Eclipse model.
- Thicker, contoured arm profiles - reduced arm deflection.
- Sealed dual ball bearing elbows with a larger radius curve - smoother operation and better arm tension.



*Solar Eclipse Arm*



# TO MEET YOUR NEEDS

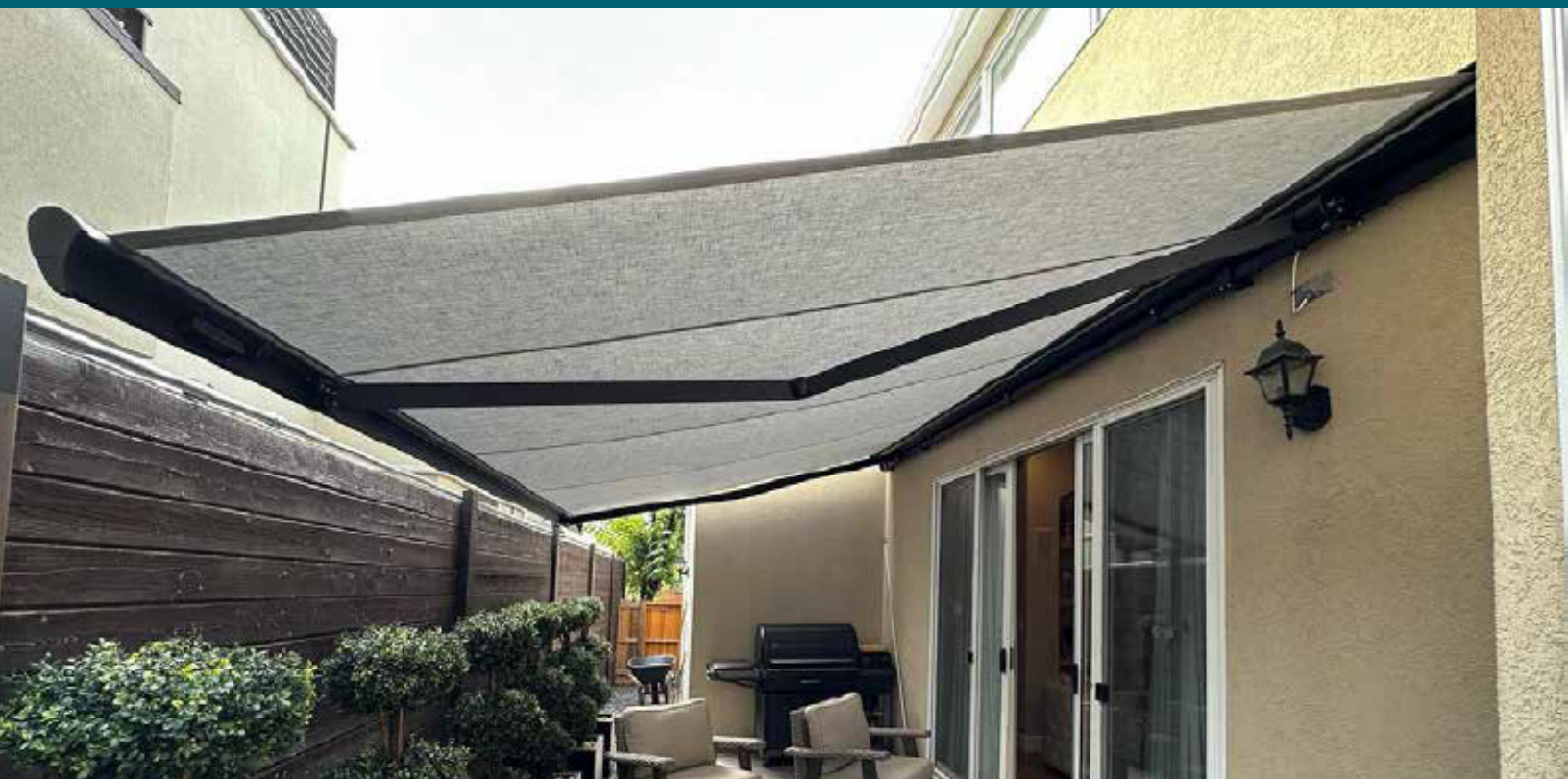

## MOTORIZED FOR EASY USE

Your Solar Eclipse features a UL listed motor from Somfy, the world leader in home automation. You can operate your shading system with a wireless wall switch, a hand held remote, from your smart device... or from all of these! To increase the usefulness and effectiveness of your shading system, plus add a level of protection, Eclipse also offers sun sensors and motion sensors.

## UNIT PROFILES (UNIT MEASUREMENTS INCLUDED)

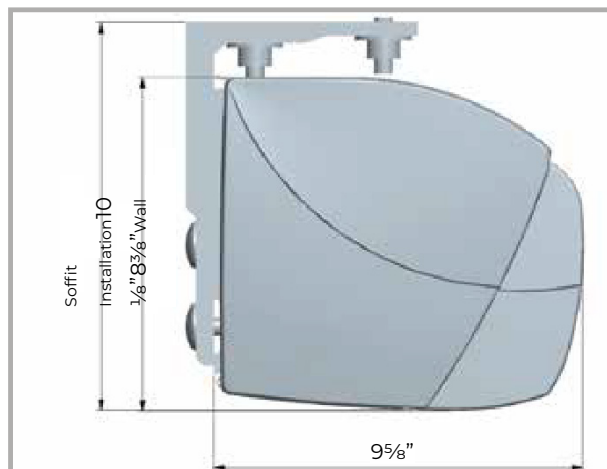

**Full Cassette (Soffit Mount)**

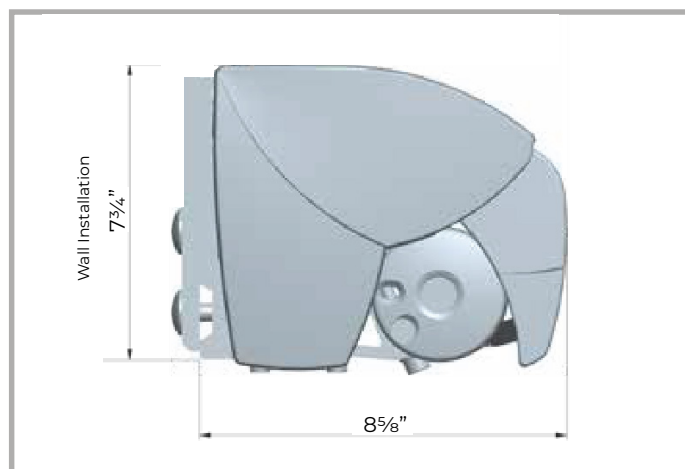

**Semi Cassette (Wall Mount)**



# PRODUCT OPTIONS

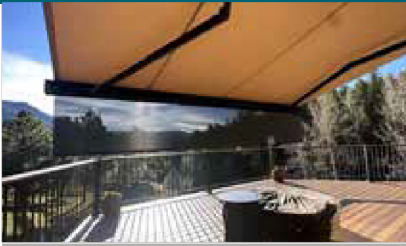

## DROP SHADE

Add even more solar protection while increasing your privacy with the Eclipse Drop Shade. This option features an open mesh, sun screen fabric that extends down from the front bar over the width of the awning. The Drop Shade is self storing, motorized and is available up to 11'6" projection.



## LUNAR LIGHTING

Add a unique element to your evening entertaining with several lighting options. Lunar Lighting (shown) is typically applied to the back of the front bar and offers a soft warm glow light which can be turned on or off with the same multi-channel remote/transmitter as your awning. An LED lighting option is available with light strips applied to the arms of the awning (dealer installed). This UL-listed LED light kit offers 16 levels of light in either warm (3000K) or cool (6000K) lighting and like lunar lighting, can be controlled with the same multi-channel remote/transmitter or multi-channel wireless wall switch. Research suggests that warm lights attract less bugs.



## ELECTRONIC ACCESSORIES

Our world class wireless components make operating your shading system effortless.

- Wind/Motion Sensor: This accelerometer sensor attached to the awning's framework will retract the unit if it gets too windy – adding a level of safety and security.
- Sun Sensor: This sensor, typically mounted to an exterior wall, will automatically extend the awning once the preset sun level is attained, and will automatically retract your shading system when the sun passes.
- TaHoma: With TaHoma®, create scenarios to link your connected devices and activate them with just a click on your smartphone!



## FULL CASSETTE HOUSING

Protect your entire unit from the elements all year long with the added protection of the full cassette option. The full cassette, like the standard semi cassette housing, is all aluminum and powder coated to match the other components of the unit. This option offers a cleaner look when fully retracted and is available up to 23'.

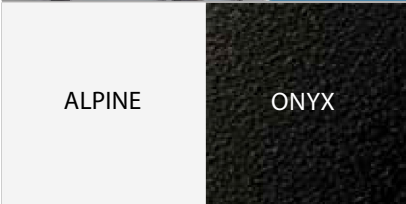

## HARDWARE TO MATCH YOUR DÉCOR

Eclipse offers two architecturally pleasing colors to either match or accentuate your home. Our pretreated powder coated finishes are second to none in durability and appearance.

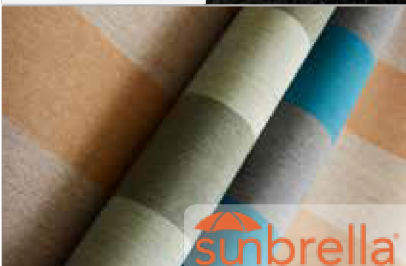

## SUNBRELLA SHADE FABRICS - FROM SERENE TO STUNNING

Eclipse offers a wide array of long lasting, fade resistant, 100% acrylic fabrics from Sunbrella. The Sunbrella Shade fabrics are specifically made for heavy duty applications such as retractable awnings. Each fabric cover is computer cut, has ultrasonically sealed edges, and is sewn with Tenera thread to provide a full 10 year warranty on the fabric and the seams. Make a bold statement or blend harmoniously to your home's décor... whatever your choice, we have the fabric for you.



## AN ADDED LEVEL OF SECURITY

Looking for a lifetime warranty on your complete shading system – from frame to fabric, motor and electronics? Ask your dealer for complete details on our platinum protection programs.



# THE NEXT GENERATION IN SHADING



## DELIVERING VALUE

Every Eclipse product is custom made and professionally installed to match your individual requirements. The Solar Eclipse is our latest European inspired shading system. With its sleek design for a clean visual when closed, the Solar Eclipse offers what today's discerning homeowners are looking for – function & form. From a very compact space, your custom made, on-demand shading system can span 23' feet wide and project up to 13' when extended.

## ELEGANT PERFORMANCE

The Solar Eclipse features components that provide a refined, finished look while adding strength and durability to the system. The aluminum powder coated torsion bar has been upgraded to a stronger, thicker wall profile to increase unit rigidity. The retractable arms are where you'll notice the greatest improvements. These arms feature larger arm profiles, a concealed heavy duty arm belt, sealed ball bearings at the elbow and an overall contoured designer shade.





# PRODUCT FEATURE OPTIONS

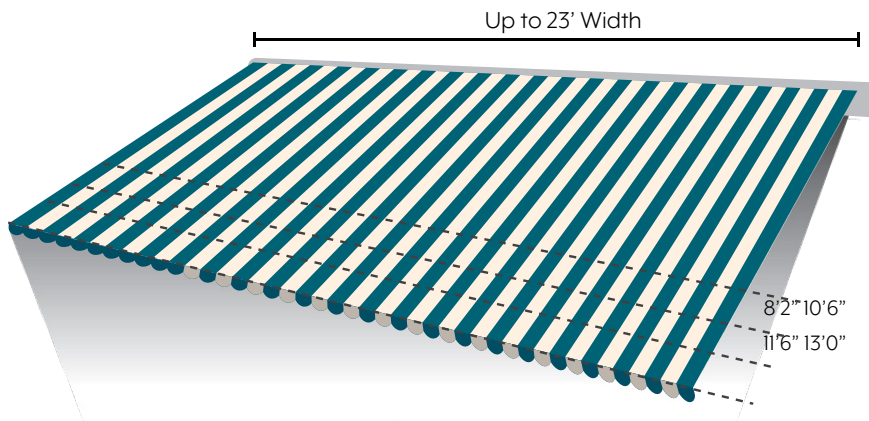

## SIZES AVAILABLE

The Solar Eclipse shading system is custom made to fit your unique space. With widths up to 23' wide and projections up to 13', we've got you covered!

The Solar Eclipse components meet stringent ISO 9001 and TUV standards and are assembled in the USA by skilled craftspeople.



## PRODUCT WARRANTY\*

Lifetime Frame  
12 years on Fabric  
8 years on motor and electronics

\*Please review warranty for complete details

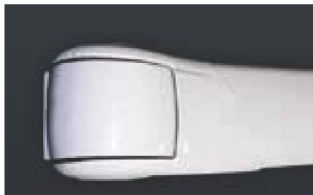

## SOLAR ECLIPSE ARMS

Incorporates sealed ball bearings and larger profiles providing smooth and quiet operation.



## CONCEALED ABT

The larger, internally hidden, belt means a cleaner finished look with a tighter fabric cover.

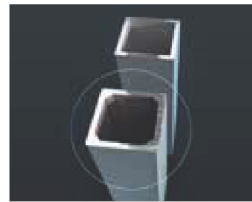

## ALUMINUM TORSION BAR

The Solar Eclipse comes standard with a heavy duty, 40mm x 40mm, galvanized steel torsion bar that is powder coated to match the framework of the awning. For coastline applications, we offer an optional 8mm thick walled powder coated aluminum torsion bar.



## MOTORIZED

Easy motorized, touch of a button operation. Includes the functionality of a manual override feature should you lose power.



99.2% of Eclipse customers would recommend us to a friend or neighbor. (based on 2022 & 2023 Eclipse owners feedback)

Verified, third party customer reviews since 1/1/18 to date  
Powered by:



★★★★★  
Product Rating 5  
★★★★★  
Dealer Rating 4.8

Your independently owned and operated dealer

For more photos, customer feedback and additional product details, please visit:

[ECLIPSESHADING.COM](http://ECLIPSESHADING.COM)



# THE TOTAL ECLIPSE





# UNIQUELY DESIGNED



## WHEN YOU JUST WANT TO GO BIG

Every Total Eclipse is custom made and professionally installed to match your individual requirements. The Total Eclipse components are up to 50% larger than our standard Eclipse awning model. The Total Eclipse, with projections up to 16'6", provides unparalleled strength, safety and security and can easily withstand changing weather conditions. When only the best will do, look no further than the Total Eclipse!



## ADVANCED BELT TECHNOLOGY

While other systems have exposed cables or chains, Total Eclipse A.B.T. consists of 11 individually wound cables encased in a poly carbon, UV resistant PVC coating. Each belt is individually tested to 3,300 pounds at 60,000 cycles which guarantees a long, worry-free life for your Total Eclipse shading system.





# TO MEET YOUR NEEDS



## MOTORIZED FOR EASY USE

Your Total Eclipse features a strong and rugged UL listed motor from Somfy, the world leader in home automation. You can operate your shading system with a wireless wall switch, a hand held remote, a smart device... or from all of these! To further increase the effectiveness of your Total Eclipse, sun, wind and rain sensors - ask your dealer for more details.



## MOUNTS ON VIRTUALLY ANY SURFACE

The Total Eclipse can be professionally installed on a roof, under a soffit or on any flat surface, based on your needs, your unit can be ordered in three ways:

- With a fully exposed rolled up fabric referred to as an "Open Roller" - typically for under soffit mounting.
- With a protective hood for wall mounting with no overhead protection.
- When additional clearance is required, we recommend the protective hood in combination with our strong and sturdy roof mount brackets.

# PRODUCT OPTIONS

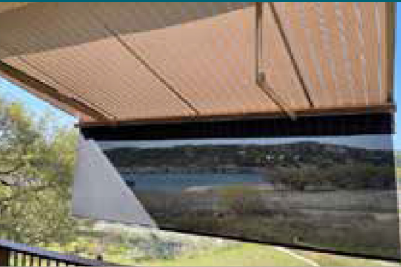

## DROP SHADE

Add even more solar protection while increasing your privacy with the Eclipse Drop Shade. This option features an open mesh, sun screen fabric that extends down from the front bar over the width of the awning. The Drop Shade is self storing and motorized.



## LUNAR LIGHTING

Add a unique element to your evening entertaining with exterior rated, soft glow Eclipse Lunar Lighting. Mounted to the underside of your awning, you can control the lighting system with the touch of a button. These UL listed lights are safe for outdoor use and will not attract insects by design.

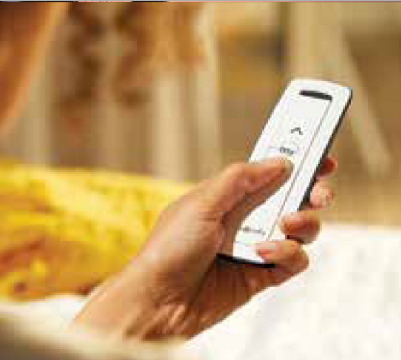

## ELECTRONIC ACCESSORIES

Our world class wireless components make operating your shading system effortless.

- Wind/Motion Sensor: This accelerometer sensor attached to the awning's framework will retract the unit if it gets too windy – adding a level of safety and security.
- Sun Sensor: This sensor, typically mounted to an exterior wall, will automatically extend the awning once the preset sun level is attained, and will automatically retract your shading system when the sun passes.
- TaHoma: With TaHoma®, create scenarios to link your connected devices and activate them with just a click on your smartphone!



## POWDER COATED, ALUMINUM PROTECTIVE HOOD

Protect your fabric from the elements all year long with a protective hood. This option, in matching awning frame hardware color, will also help extend the life of the motor. The protective hood is available up to 40' wide and includes matching side covers for added protection.

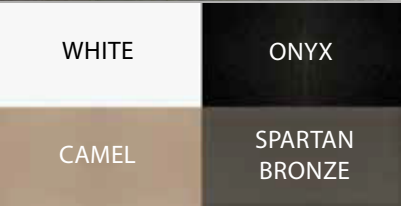

## HARDWARE TO MATCH YOUR DÉCOR

Eclipse offers four architecturally pleasing colors to either match or accentuate your home. Our pretreated powder coated finishes are second to none in durability and appearance.



## SUNBRELLA SHADE FABRICS - FROM SERENE TO STUNNING

Eclipse offers a wide array of long lasting, fade resistant, 100% acrylic fabrics from Sunbrella. The Sunbrella Shade fabrics are specifically made for heavy duty applications such as retractable awnings. Each fabric cover is computer cut, has ultrasonically sealed edges, and is sewn with Tenera thread to provide a full 10 year warranty on the fabric and the seams. Make a bold statement or blend harmoniously to your home's décor... whatever your choice, we have the fabric for you.



## AN ADDED LEVEL OF SECURITY

Looking for a lifetime warranty on your complete shading system – from frame to fabric, motor and electronics? Ask your dealer for complete details on our platinum protection programs.





# THE NEXT GENERATION IN SHADING



## COMMERCIAL GRADE SHADING SYSTEM

Every Total Eclipse is custom made and professionally installed to match your individual requirements. The Total Eclipse is the only system on the market that offers projections up to 16'6" providing unparalleled strength, durability & security. So whether you add one to your outdoor dining area or to your home, feel confident that you have selected the finest shading system!

## SELF STORING WHEN NOT IN USE

The beauty of today's Eclipse retractable awnings is their self-storing nature. With a simple press of a button, or a command on your smart phone, the shading system fully retracts and stops automatically, and (if so equipped) will be self stored under the protective hood.



# PRODUCT FEATURE OPTIONS

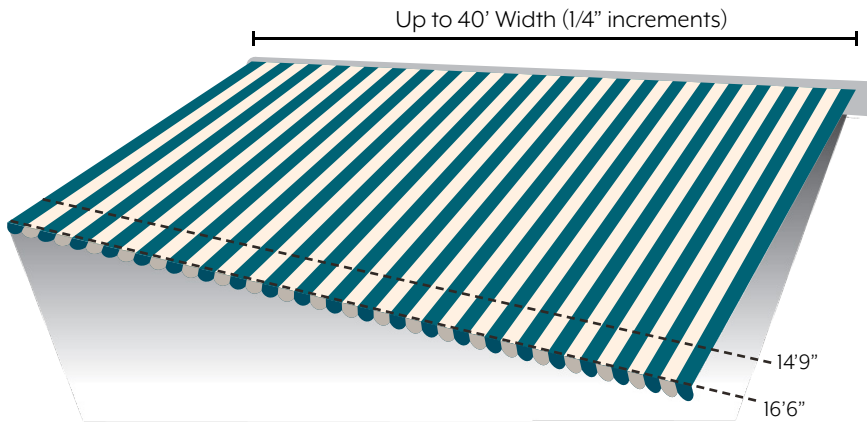

## SIZES AVAILABLE

The Total Eclipse shading system is custom made to fit your unique space. With widths up to 40' wide and projections up to 16'6", we got you covered!

The Total Eclipse components meet stringent ISO 9001 and TUV standards and are assembled in the USA by skilled craftspeople.



## PRODUCT WARRANTY\*

Lifetime Frame  
12 years on Fabric  
8 years on motor and electronics  
\*Please review warranty for complete details



## TORSION BAR CONSTRUCTION OPTIONS

The Total Eclipse comes standard with a heavy duty 50mm x 50mm, galvanized steel torsion bar that is powder coated to match the framework of the awning. For coastline applications, we offer an optional 8mm thick walled aluminum torsion bar.



## ADVANCED BELT TECHNOLOGY

The Eclipse exclusive tension transmission system, has been tested and proven for almost two decades on performance. This design does not stretch or breakdown over time, keeping your fabric taut for years to come.



## MOTORIZED

Easy motorized touch of a button, Operation includes the functionality of a manual override feature should you lose power.

## ARM LIFE EXPECTANCY:

➔	ABT	—	<b>60,000 Cycles</b>
	CHAIN	—	8,000 Cycles
	CABLE	—	5,000 Cycles



Your independently owned and operated dealer

99.2% of Eclipse customers would recommend us to a friend or neighbor. (based on 2022 & 2023 Eclipse owners feedback)

Verified, third party customer reviews since 1/1/18 to date  
Powered by:



★★★★★  
Product Rating 4.3  
★★★★★  
Dealer Rating 4.8

For more photos, customer feedback and additional product details, please visit:

**ECLIPSESHADING . COM**



# THE DROP ARM





# UNIQUELY DESIGNED



## REDUCE COOLING AND FADING - WHILE ADDING COLOR AND STYLE

Add the look of old world charm to your home, outdoor structure or store front with Eclipse Drop Arm awnings. This green solution to your solar problem starts by choosing from over 150 long lasting, 100% acrylic fabrics that will not rot, mildew or fade – guaranteed. By adding Drop Arms to your home or business, you add appealing dimension to the structure.



## ADVANCED BELT TECHNOLOGY

Just like the rest of the Eclipse line of shading products, the Drop Arm incorporates our unique and exclusive ABT tension transfer system that utilizes multiple steel cables in a poly carbon, UV resistant coating. Unlike exposed steel cables or chains, your Eclipse Drop Arm has been tested to 60,000 cycles, far outlasting the competition.





# TO MEET YOUR NEEDS



## MOTORIZED FOR EASY, WORRY FREE PROTECTION

To get the most out of your shading system, order it motorized! This will allow you to operate your Drop Arm or multiple units with a wireless wall switch, a hand held remote, a smart device...or from all of these! You also have the option to add automatic sensors that will adjust your shading system throughout the day.



## YOU CONTROL THE SUN ALL YEAR LONG

Because of the retractable nature of the Drop Arm, you can adjust the product to best suit your shading or privacy needs. You will reduce interior room temperatures up to 20 degrees by stopping the sun's heat before it reaches the glass. For low sun, The Drop Arm can be fully extended to provide virtually complete coverage of the window or opening.

# PRODUCT OPTIONS



## MOTORIZED - MAKE YOUR LIFE EASIER

To provide you with touch of a button operation, we offer UL listed tubular motors. Ask your dealer which motor and electronic accessories will best meet your needs.



## POWDER COATED, ALUMINUM PROTECTIVE HOOD

Protect your fabric from the elements all year long with a protective hood. This option, matching awning frame hardware color, will also help to extend the life of the motor. The protective hood is available up to 30' wide and includes aluminum side covers and stainless steel hardware for added, long term shelter.



## ELECTRONIC ACCESSORIES

Our world class wireless components make operating your shading system effortless.

- Wind/Motion Sensor: This accelerometer sensor attached to the awning's framework will retract the unit if it gets too windy – adding a level of safety and security.
- Sun Sensor: This sensor, typically mounted to an exterior wall, will automatically extend the awning once the preset sun level is attained, and will automatically retract your shading system when the sun passes.
- TaHoma: With TaHoma®, create scenarios to link your connected devices and activate them with just a click on your smartphone!

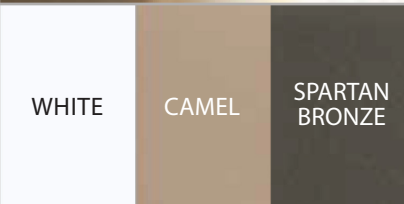

## HARDWARE TO MATCH YOUR DÉCOR

Eclipse offers three architecturally pleasing colors to either match or accentuate your home. Our pretreated powder coated finishes are second to none in durability and appearance.



## SUNBRELLA SHADE FABRICS - FROM SERENE TO STUNNING

Eclipse offers a wide array of long lasting, fade resistant, 100% acrylic fabrics from Sunbrella. The Sunbrella Shade fabrics are specifically made for heavy duty applications such as retractable awnings. Each fabric cover is computer cut, has ultrasonically sealed edges, and is sewn with Tenera thread to provide a full 10 year warranty on the fabric and the seams. Make a bold statement or blend harmoniously to your home's décor... whatever your choice, we have the fabric for you.



## ADD A LEVEL OF SECURITY

Looking for a lifetime warranty on your complete shading system – from frame to fabric, motor and electronics? Ask your dealer for complete details on our Platinum Protection programs.



# THE NEXT GENERATION IN SHADING



## FEEL THAT OLD WORLD CHARM AGAIN

The Eclipse Drop Arm will give you the elegance and serenity of the past with today's technology. Incorporating the finest, most durable components available, the Drop Arm will provide years of trouble free solar protection. With three hardware colors to choose from, custom sizing and a full color palette of fabrics, your Eclipse shading expert will custom design and install Drop Arm awnings that you will enjoy every time you see your home.

## SELF STORING WHEN NOT IN USE

With 170 degrees of adjustable inclination, you determine how much of the sun's heat and light you need. When you desire full exposure your Drop Arm awnings can be fully retracted under their optional protective hood or stored under an overhang, protecting the fabric from the elements.



*Optional Hood*

# PRODUCT FEATURE OPTIONS

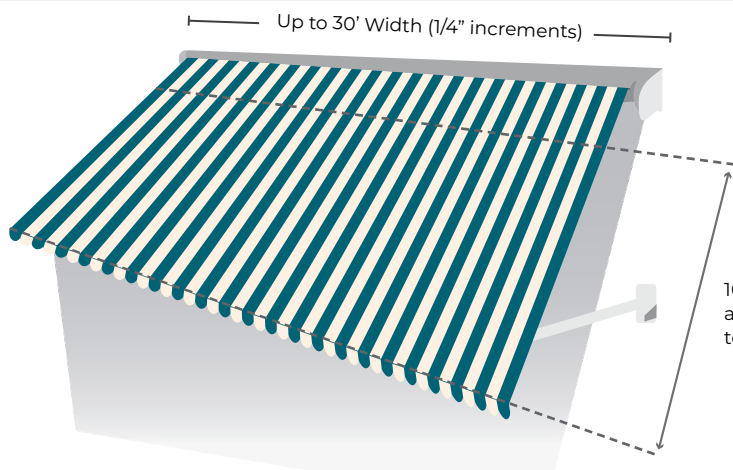

## SIZES AVAILABLE

Widths: up to 30'0" (1/4" increments)  
 Projections/Drops: from 2'0" to 5'0"  
 (in 4" increments - 10 sizes available)

The Eclipse Drop Arm components meet stringent ISO 9001 and TUV standards and are assembled in the USA by skilled craftspeople.



## PRODUCT WARRANTY\*

10 years on Framework  
 10 years on Fabric  
 5 years on motor and electronics  
 \*Please review warranty for complete details

## ADVANCED BELT TECHNOLOGY (ABT)

The Eclipse exclusive, tension transmission system, our ABT is also incorporated in our Drop Arm units to keep your fabric taut for years to come. The ABT, like our higher end retractable systems is hidden from view to provide a cleaner, more refined look.

## ARM LIFE EXPECTANCY:

➔ ABT	— 60,000 Cycles
CHAIN	— 8,000 Cycles
CABLE	— 5,000 Cycles

DEGREE OF INCLINATION	
Wall Mounting	Ceiling/Soffit Mounting

## MOUNTING AND ADJUSTABILITY

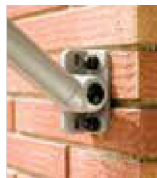

Drop Arm awnings can be wall or ceiling mounted to provide shade where you need it. The spring loaded arms provide you the option to adjust the unit from fully retracted to full coverage.



Your independently owned and operated dealer

99.2% of Eclipse customers would recommend us to a friend or neighbor. (based on 2022 & 2023 Eclipse owners feedback)

Verified, third party customer reviews since 1/1/18 to date  
 Powered by:



★★★★★  
 Product Rating 4.7  
 ★★★★★  
 Dealer Rating 4.8

For more photos, customer feedback and additional product details, please visit:

[ECLIPSESHADING.COM](http://ECLIPSESHADING.COM)